

UPTOWN[®]
ALFRESCO

UTR8-A

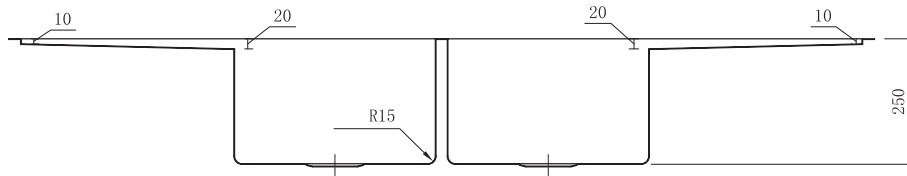
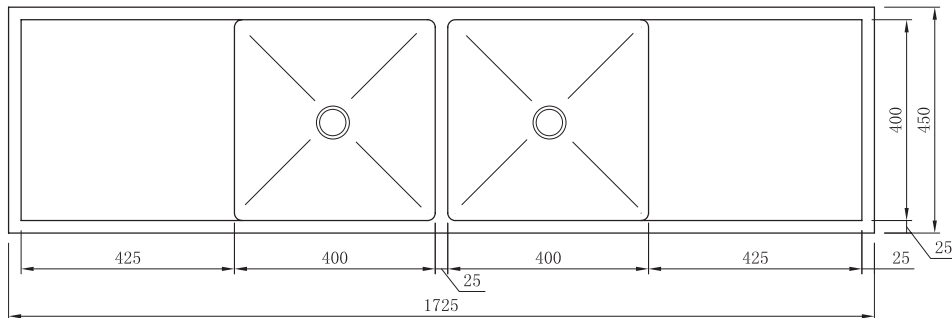
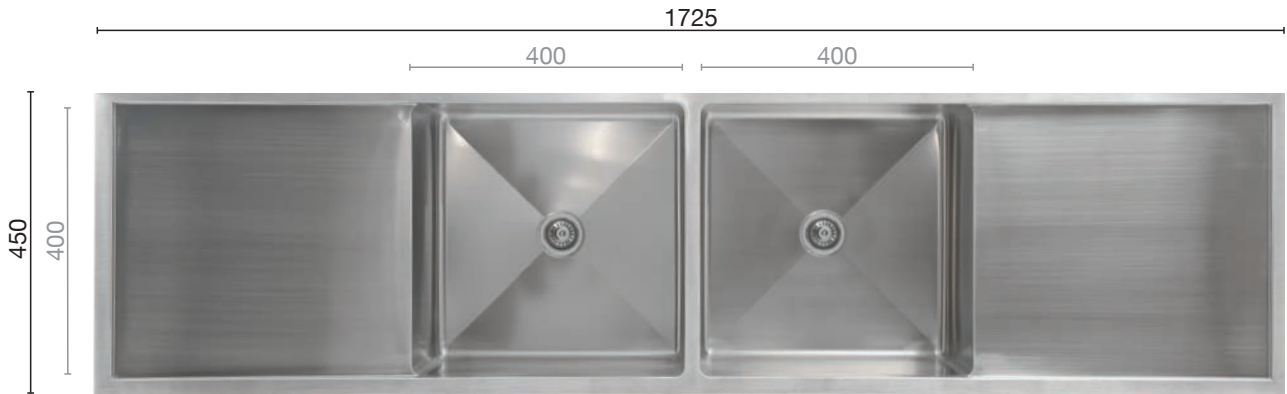

Product Details

- **#316 Marine Grade Stainless Steel**
- Easy clean radius corners
- Includes stainless steel designer basket wastes
- Suitable for **Top Mount** or **Under Mount** installation
- All bowls **250mm deep**



VICTORIA
Interchange Sales & Marketing P/L
Unit 4/49 Corporate Blvd
Bayswater Vic 3153
Ph: 03 9729 6411
Fax: 03 9729 5722
Email: interchange@netspace.net.au
www.interchangesales.com.au

NSW & QUEENSLAND
Broadway Bathroomware
27 Shirlow St
Marrickville NSW 2204
Ph: 02 9907 2505
Fax: 02 9907 2504
Email: baths@bigpond.net.au
www.broadwaybaths.com.au

SOUTH AUSTRALIA
Enterprise Agencies P/L
PO Box 731
Mitcham SA 5062
Ph: 08 8443 8889
Fax: 08 8443 5889
Email: entag@adam.com.au

TASMANIA
Allan Powell Agencies
Warehouse 1, Broadland Dve
Launceston TAS 7250
Ph: 03 6334 2992
Fax: 03 6334 2994
Email: apagencies@apagencies.com