

UPTOWN

SINKS

PB350

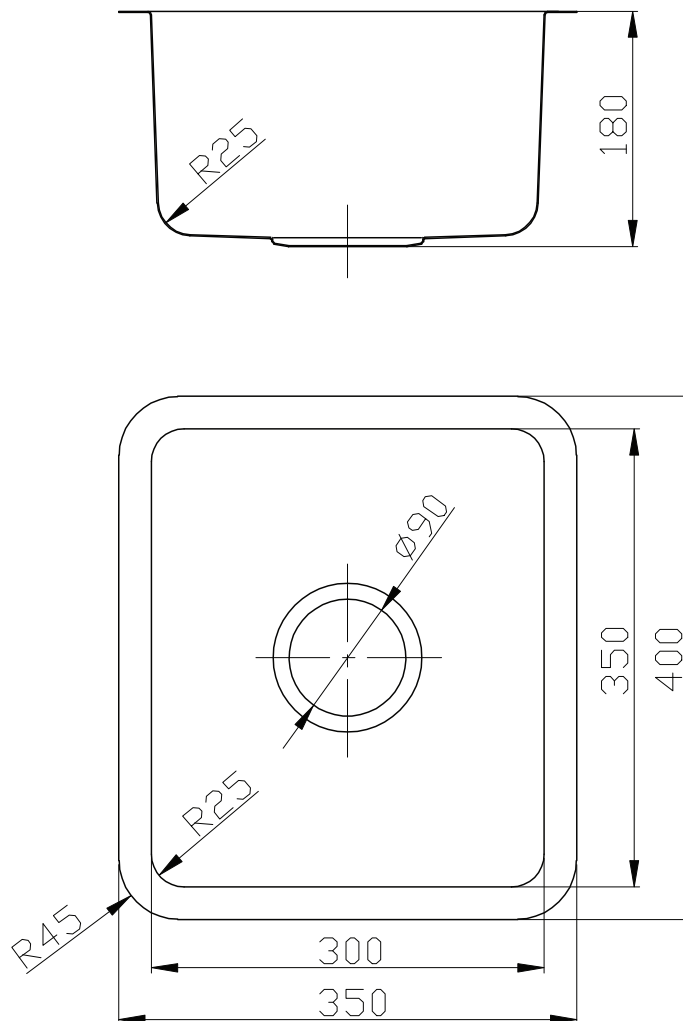

350 x 400 x 160mm (overall)
300 x 350 x 160mm (bowl)

- Made from 304 grade stainless steel.
- Supplied with clips and sealing tape where applicable.
- Supplied with Basket Strainer Waste



VICTORIA
Interchange Sales & Marketing P/L
Unit 4/49 Corporate Blvd
Bayswater Vic 3153
Ph: 03 9729 6411
Fax: 03 9729 5722
Email: interchange@netspace.net.au
www.interchangesales.com.au

NSW & QUEENSLAND
Broadway Bathroomware
27 Shirlow St
Marrickville NSW 2204
Ph: 02 9907 2505
Fax: 02 9907 2504
Email: baths@bigpond.net.au
www.broadwaybaths.com.au

SOUTH AUSTRALIA
Enterprise Agencies P/L
PO Box 731
Mitcham SA 5062
Ph: 08 8443 8889
Fax: 08 8443 5889
Email: entag@adam.com.au

TASMANIA
Allan Powell Agencies
Warehouse 1, Broadland Dve
Launceston TAS 7250
Ph: 03 6334 2992
Fax: 03 6334 2994
Email: apagencies@apagencies.com